

Tuintafel Max - 150 x 80 cm

MaximaVida
Products designed for living

OP-MTTM-V2

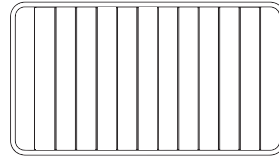
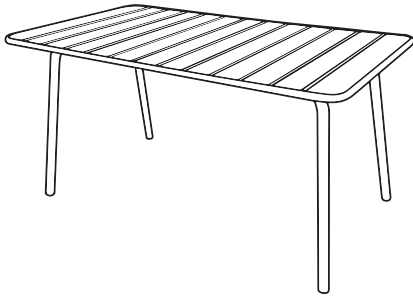

A. 1x

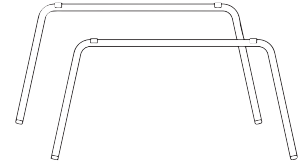

B. 2x



1. 8x



2. 8x



3. 8x

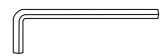

4. 1x

Tip!

Zorg ervoor dat je de onderdelen voorzichtig uitpakt en plaatst op een zachte ondergrond, bv op een zachte deken.

Controleer daarna alle onderdelen op schade voordat je begint met monteren. Opgebouwde producten kunnen niet worden gereclameerd.

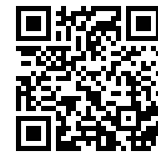

Bekijk je liever de video?
Scan dan de QR-code.

1

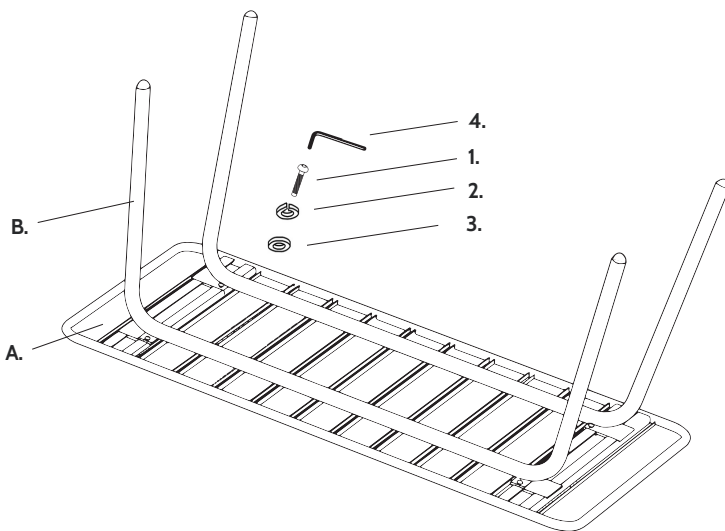

2

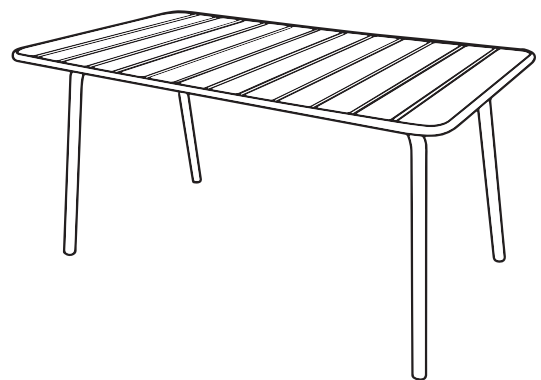

Care instructions

- Tighten the screws at the end of the construction and check them regularly afterwards.
- Do not use power screw drivers as they might cause splitting.
- Only use special cleanser or impregnate oil to clean wooden products and water and soap for aluminium and steel products.
- Use soft brushes when cleaning to avoid scretching the surface.
- Protect your furniture/products with a cover when you are not using it.

maximavida.com
Den Sliem 42
7141 JH Groenlo
+31 544 37 54 45
info@maximavida.com